

DETAIL OF MOUNTING BLOCK

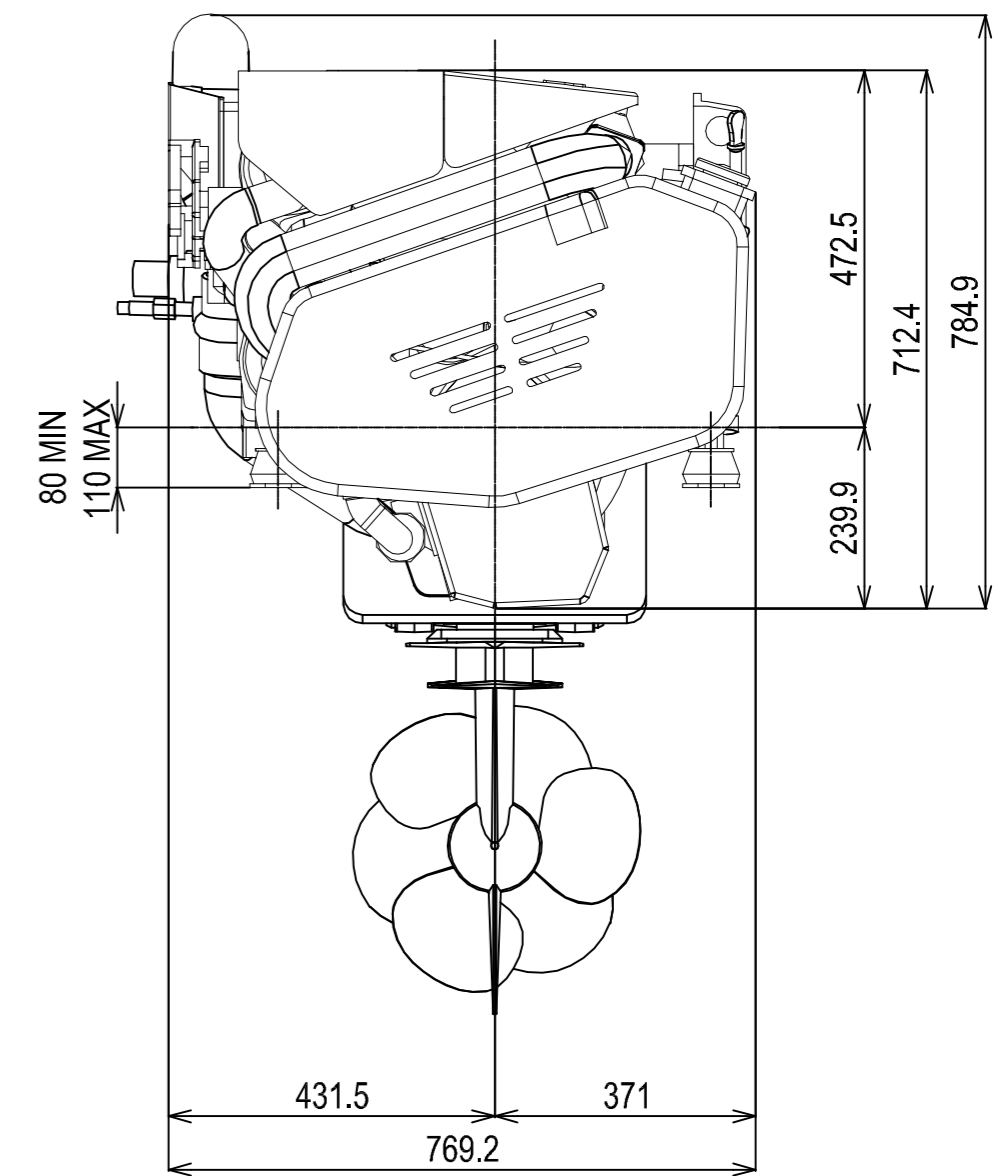
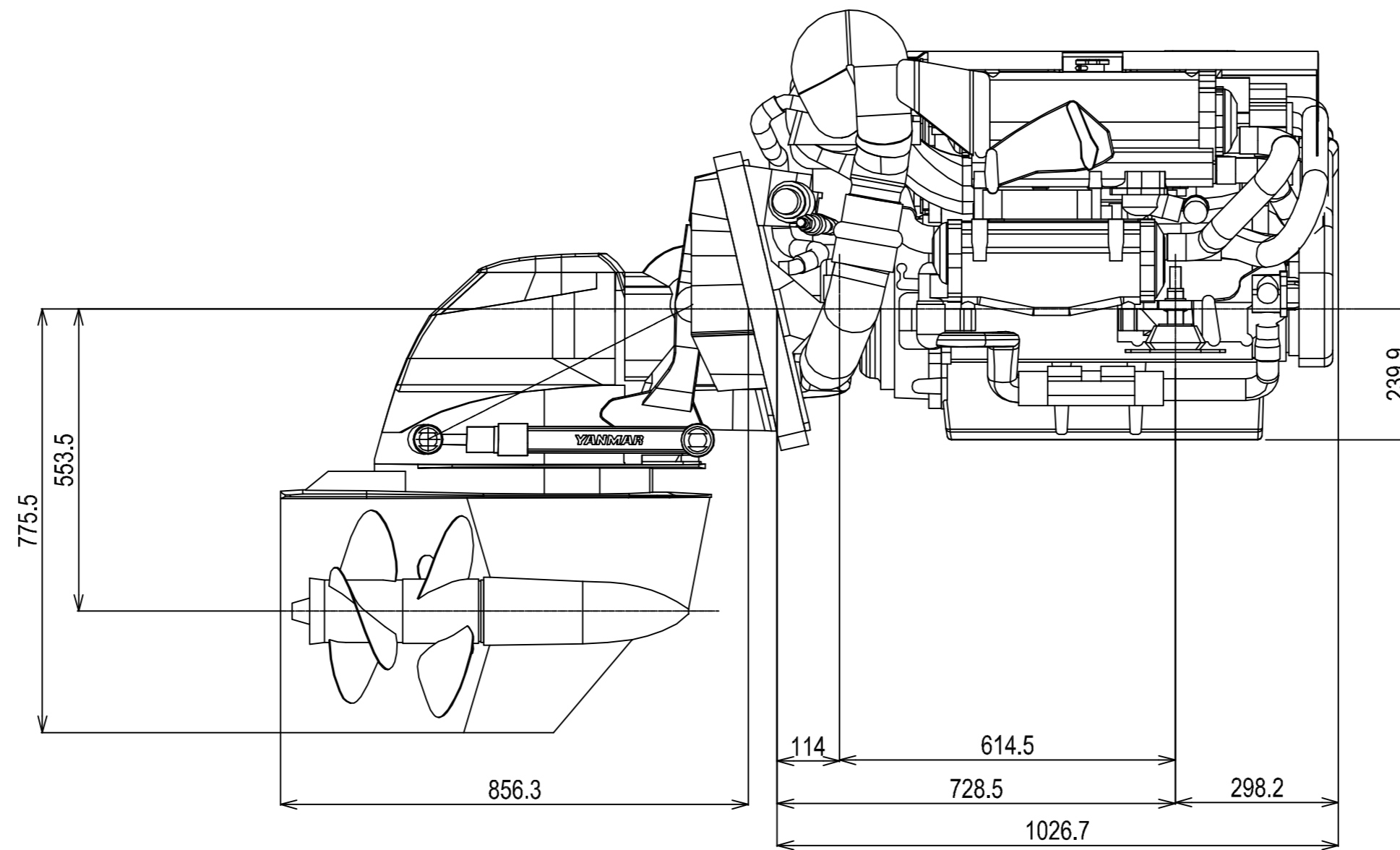
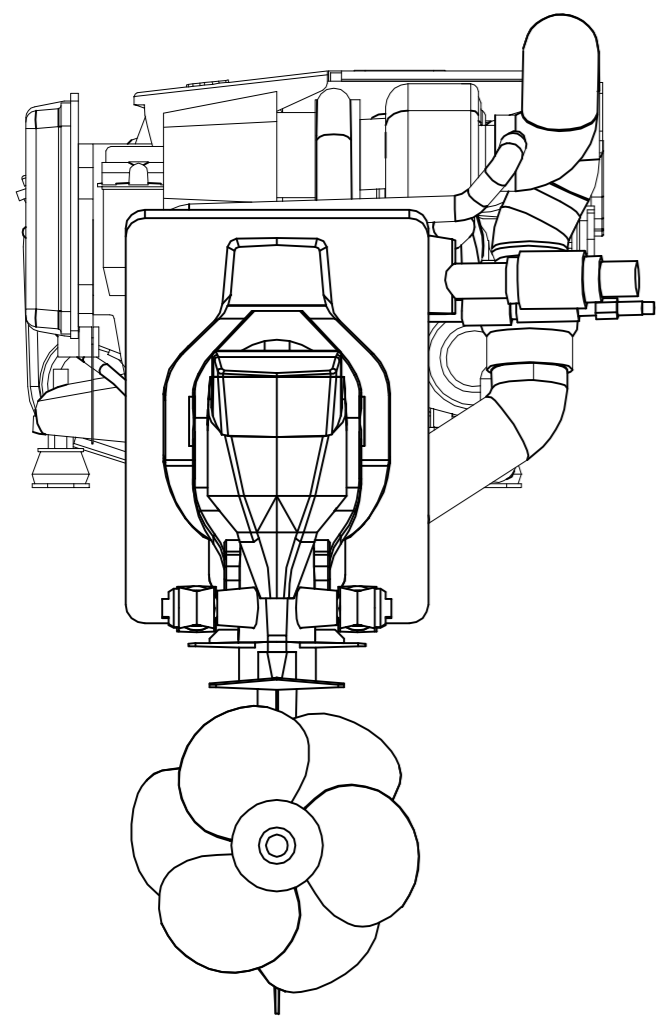
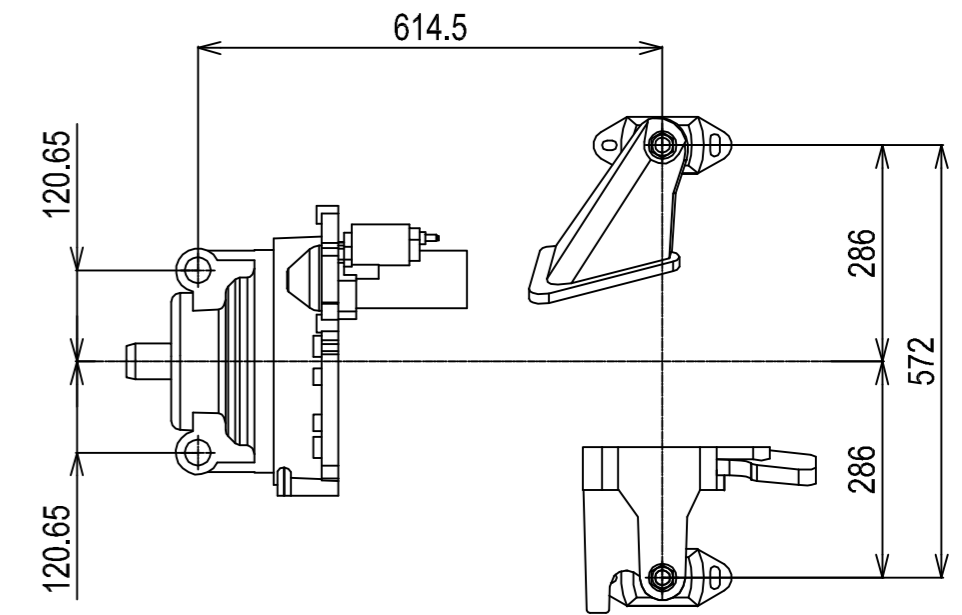
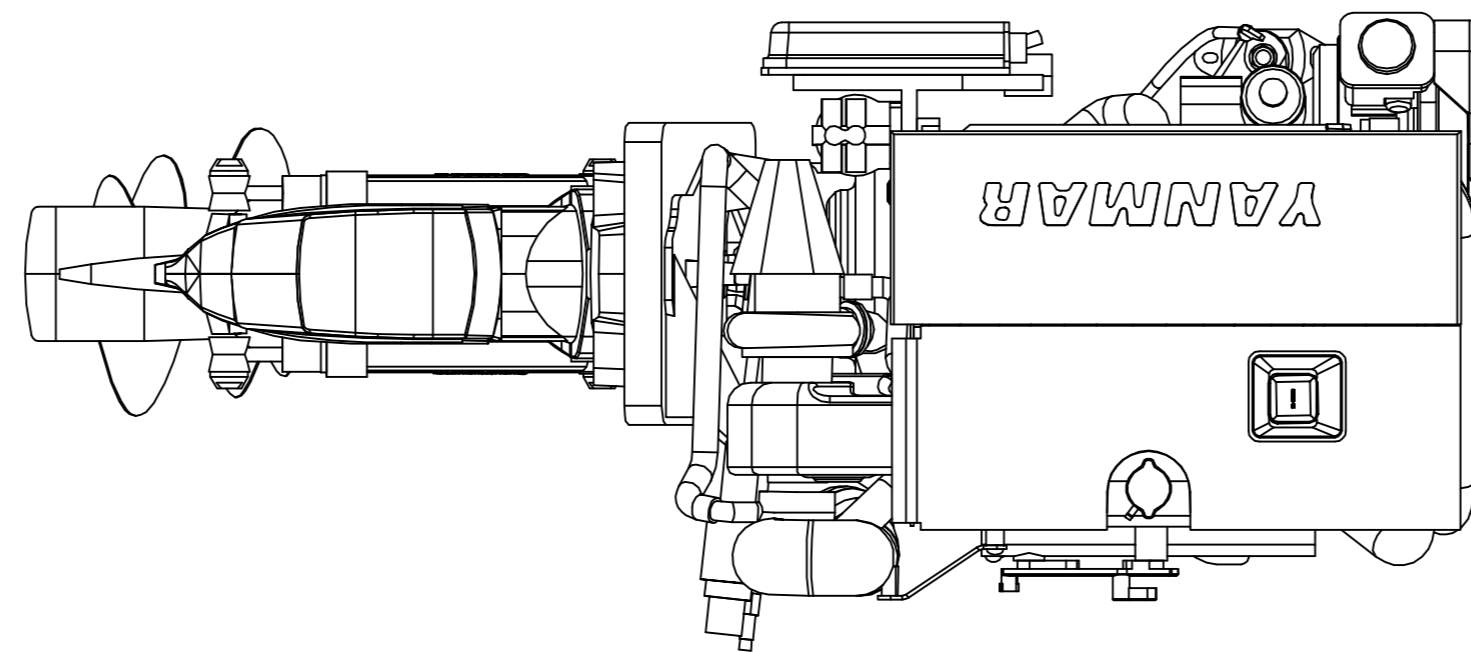
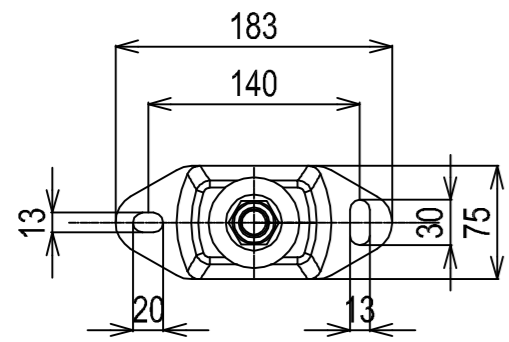

NOTE:

1. DWG. SHOWS MOUNTING BLOCKS AT ORIGINAL HEIGHT. ENGINE WEIGHT WILL COMPRESS BLOCKS BY 4MM (APPROX).
2. MOUNTING BLOCKS ARE EQUIPPED FOR STANDARD ACCESSORY.
3. ● SHOWS THE CENTER OF GRAVITY.
4. FOR ADDITIONAL INSTALLATION INFORMATION AND SPECIFICATIONS PLEASE REFER TO THE YANMAR ENGINE INSTALLATION MANUAL

Series: BY	Engine: 6BY2-260Z(220Z)xZT350	Release: R2008-01
Scale: 1:10	Date: 01-12-08	Dimensions: mm

